

PRODUCT CATALOGUE

**POOL & SPA
EQUIPMENT**

**POOL & SPA
CHEMICALS**

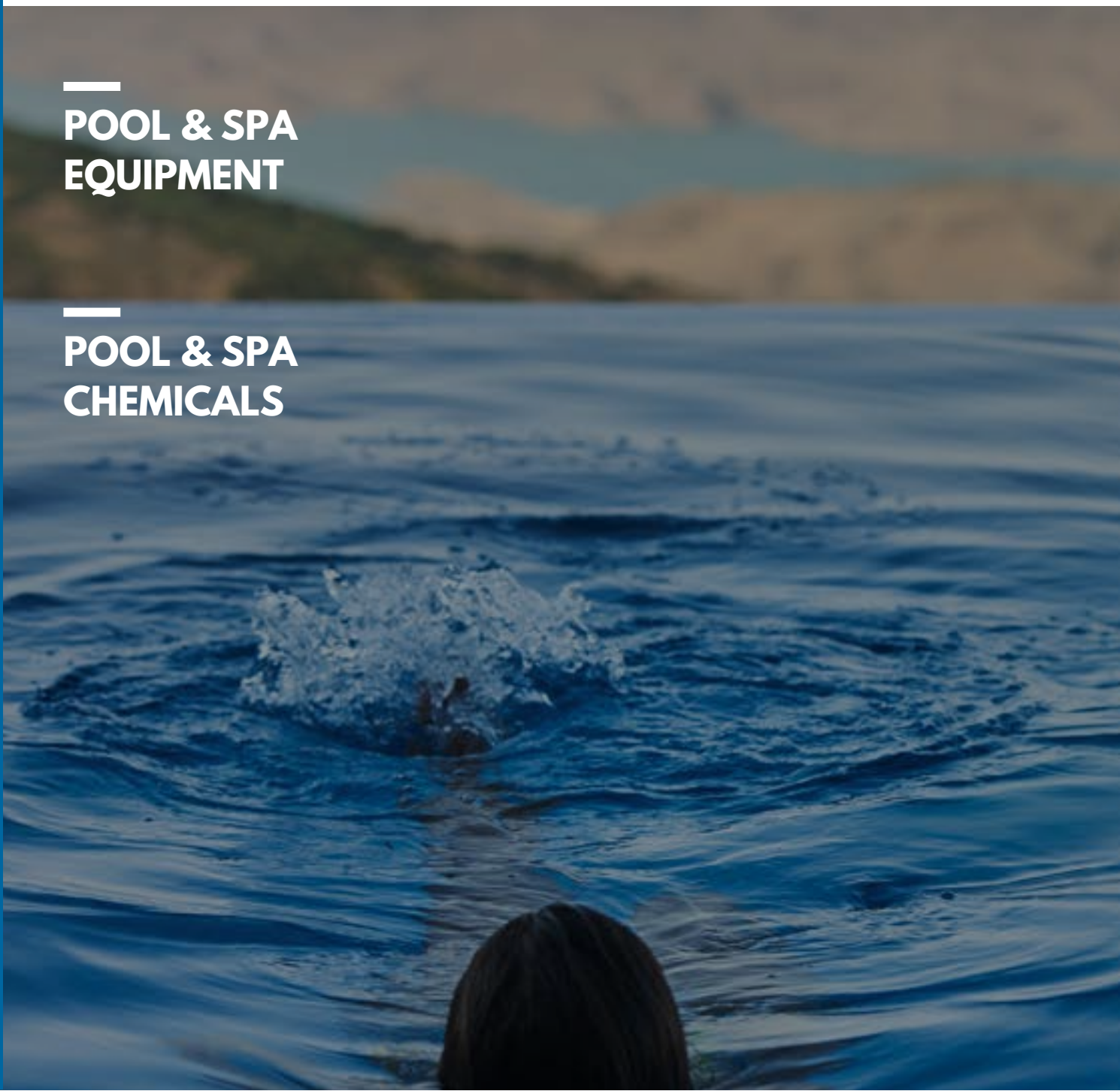



WE ARE NZ'S LEADING SUPPLIER IN THE INDUSTRY OF POOL AND SPA CHEMICALS AND EQUIPMENT.

We specialise in the manufacturing, importing and distribution of quality, value added pool and spa chemicals and equipment. With over 40 years of experience in the industry, we have created reputable brands and products found in pool and spa shops and larger FMCG stores nationwide. We are proud to be New Zealand's leading supplier in the industry.



Industry Experts

Over 40 years of experience in chemical manufacturing and distribution. We are the best at what we do.



Reputable Brands

We distribute only the most reputable brands in the pool and spa industry, from chemicals to equipment.



Service and Support

Customer satisfaction is at the heart of what we do. We see every customer as a key partner.

CONTACT US

North Island

Viviane Walker 021 811 992
viviane.walker@spaceindustries.co.nz

Gary Mcleod 027 473 4486
gary.mcleod@spaceindustries.co.nz

Peter Kruse 027 478 8060
peter.kruse@spaceindustries.co.nz

South Island

Warren Jones 027 464 9110
warren.jones@spaceindustries.co.nz

Customer Service

Dianne Eldialde
reception@spaceindustries.co.nz

Head Office

160 Plunket Ave, Manukau
Auckland 2104

09 262 3902
www.spaceindustries.co.nz



Space Industries is a proud subsidiary of
TCL Hunt and is a member of the
Ravago Group



INDEX

TABLE OF CONTENTS



02

POOL & SPA
EQUIPMENT

03

ROBOTIC POOL
CLEANERS

08

POOL & SPA
HEAT PUMPS

17

SALT
CHLORINATORS

24

POOL & SPA
PUMPS

35

SAND FILTERS &
COMBO KITS

40

POOL VACUUM
CLEANERS

43

CONSUMABLES

50

POOL & SPA
CHEMICALS

51

BALANCE
CHEMICALS

54

ALGAECIDE
CHEMICALS

57

SANITISER
CHEMICALS

63

SPECIALTY
PRODUCTS

70

WATER TESTING
SOLUTIONS



POOL AND SPA EQUIPMENT

ROBOTIC POOL CLEANERS





BWT COSMY BOT ROBOTIC POOL CLEANER

AVAILABLE IN

| MODEL | PRODUCT CODE |
|-------|--------------|
| 100 | BWTC100 |
| 150 | BWTC150 |
| 200 | BWTC200 |
| 250 | BWTC250 |

PRODUCT OVERVIEW

- Lightweight and compact design—only 5.7KG.
- 15m³/h suction flow and 3 motors in 1 for a powerful cleaning experience.
- COSMY 100 cleans pool floors, COSMY 150–250 cleans floors, wall and waterline.
- COSMY 200 and 250 are compatible with the BWT app for full control via smartphone.
Customisable with 7 available colour sets and 1 extra colour set comes with purchase.

TECHNICAL PARAMETERS

| |  |  |  |  |
|-----------------------|---|---|---|---|
| | BOT 100 | BOT 150 | BOT 200 | BOT 250 |
| SPECIFICATIONS | | | | |
| Weight | 5.7kg | 5.7kg | 5.7kg | 5.7kg |
| Power supply | < 29 Volt | < 29 Volt | < 29 Volt + App | < 29 Volt + App |
| Power consumption | < 150 Watt | < 150 Watt | < 150 Watt | < 150 Watt |
| EQUIPMENT | | | | |
| Filter type | Single layer filtration | Single layer filtration | Dual layer filtration | Dual layer filtration |
| Filter access | Top access Full filter indicator | Top access Full filter indicator | Top access Full filter indicator | Top access Full filter indicator |
| Brush type | PVC brushes | PVC brushes | PVC brushes | PVC brushes |
| Cable Length | 12m | 16m | 16m | 16m |
| CLEANING | | | | |
| Pool size | Up to 8m | Up to 10m | Up to 12m | Up to 12m |
| Pool shape | All shapes & finishes | All shapes & finishes | All shapes & finishes | All shapes & finishes |
| Cleaning type | Floor | Floor, walls & water line | Floor, walls & water line | Floor, walls & water line |
| Cleaning cycle durat | 1.5 hours | 2 hours | 1.5, 2 or 2.5 hours | 1.5, 2 or 2.5 hours |
| Smart phone APP | No | No | Yes | Yes |
| Storage accessory | Optional | Optional | Optional | Premium caddy |
| Navigation technology | Smart navigation Gyroscope Beach entry detection | Smart navigation Gyroscope Beach entry detection | Smart navigation Gyroscope Beach entry detection | Smart navigation Gyroscope Beach entry detection |

7 COLOUR SETS AVAILABLE



CLEAN WHAT YOU CAN'T SEE.

The BWT D-Line features 4D hyperfine filtration,® a system that captures even the smallest grain of sand.



BWT D200 ROBOTIC POOL CLEANER
PRODUCT CODE: BWTD200



- Suits Pools 14 Metres Long
- Cleans The Floor, Walls And Waterline
- Compatible With Every Pool Shape And Surface Finish (Fibreglass, Concrete, Liner, Tiles, Etc.)
- Duration Of The Cleaning Cycle: 2h
- Warranty Of 2 Years



TECHNICAL PARAMETERS

| BWT D200 | | | |
|-------------------|-------------------------|------------------------|---------------------|
| Pool size | up to 14m | Dimensions (l x w x h) | 39 x 47 x 27 |
| Filter Type | 4D hyperfine microfibre | Suction flow rate | 19m ³ /h |
| Navigation system | Smart navigation | Cable length | 18m |
| Gyroscope | Onboard Gyro | Weight | 11 kg |
| Cleaning cycle | 2 hours | Power supply | <29 Volt SPS Basic |
| Cleaning type | Floor, walls, waterline | Power consumption | <150 watt |
| Platform | Dual Drive Breezer | Warranty | 2 years |

BWT D300 ROBOTIC POOL CLEANER
PRODUCT CODE: BWTD300



- Suits Pools 16 Metres Long
- Cleans The Floor, Walls And Waterline
- Compatible With Every Pool Shape And Surface Finish (Fibreglass, Concrete, Liner, Tiles, Etc.)
- Duration Of The Cleaning Cycle: 1.5h, 2h Or 2.5h (Cycles Can Be Managed Through The BWT RC App)
- Warranty Of 3 Years
- Caddy Included



TECHNICAL PARAMETERS

| BWT D300 | | | |
|-------------------|-------------------------|------------------------|---------------------|
| Pool size | up to 16m | Dimensions (l x w x h) | 39 x 47 x 27 |
| Filter Type | 4D hyperfine microfibre | Suction flow rate | 19m ³ /h |
| Navigation system | Smart navigation | Cable length | 23m |
| Gyroscope | Onboard Gyro | Weight | 11 kg |
| Cleaning cycle | 1.5, 2 or 2.5 hours | Power supply | <29 Volt SPS Basic |
| Cleaning type | Floor, walls, waterline | Power consumption | <150 watt |
| Platform | Dual Drive Breezer | Warranty | 3 years |



WYBOTICS OSPREY 200 CORDLESS ROBOTIC POOL CLEANER

PRODUCT
CODE

WYBOT1102

PRODUCT OVERVIEW

A functional, everyday cordless robotic pool cleaner suitable for most small to medium sized above ground pools with 2m depth. Weighing in at a light 3.6 kg, the Osprey 200 is perfect for a quick clean up. Simply charge the robot (with a full charging time of 3-4 hours) and let it run at its running capacity of 50 minutes. It features a reliable filter capability of up to 120L/min, ensuring that particles and dirt are caught. Easy to store for future use and a great all around robot.

TECHNICAL PARAMETERS

| Osprey 200 | | | |
|-------------------|------------------|------------------------|-----------------|
| Filter density | 180µ | Dimensions (l x w x h) | 34 x 35 x 33 cm |
| Filter capability | 120L/min | Charging time | 3-4 hours |
| Moving speed | 16m/min | Power | 30 watt |
| Water depth | 2.5m | Working voltage | 11V |
| Cleaning cycle | 50 mins | Adapter input voltage | 100Vac-240Vac |
| Cleaning type | Floor | Adapter output voltage | 12.6Vdc |
| Cleaning surface | 50m ² | Weight | 3.6 kg |





POOL HEAT PUMPS



THERE IS NO PERFECT POOL HEAT PUMP, UNTIL NOW.



INTRODUCING THE AQUARK MR. PERFECT

Featuring state-of-the-art InverPad® Turbo technology, utilising the most advanced silent technology in Turbofan. Combined with aerodynamic optimisation and the best noise cancelling technologies to set a new milestone in noise reduction.

AQUARK®
iOutdoor Living



MR. PERFECT

Perfect Silence

20 times more silent.
As low as

38.4
dB(A)

0 Mechanical Noise



ADVANCED CONTROLLER

The improved controller provides simple operation with advanced data monitoring. It also combines full panel tempered glass and responsive back lighting for a highly sophisticated appearance.



ANYWHERE, ANYTIME

Control your heat pump with the INVERGO APP



Available on the
Apple App Store and
Google Play



AQUARK MR. PERFECT POOL HEAT PUMP

AVAILABLE IN

| KW | PRODUCT CODE |
|-------------|------------------|
| 17KW | QAHPMP170 |
| 22KW | QAHPMP220 |

PRODUCT OVERVIEW

Introducing the Aquark Mr. Perfect, the most silent pool heat pump on the market, featuring its patented INVERPAD® TURBO technology, ensuring the unit runs at a pin drop 38.4 db(A). Featuring a state-of-the-art control system, it provides simple operation with advanced data monitoring. It also combines a digital display featuring a full panel tempered glass and responsive back lighting for a highly sophisticated appearance. Up to 69% more energy efficient than traditional pool heat pumps. Easy to control through your smartphone via the InverGo app, available on the Apple App Store and Android Google Play.

TECHNICAL PARAMETERS

| Model | 17kW | 22kW |
|---|------------------------|------------------------|
| Advised Pool Volume (m³) | 55 - 85 | 75 - 105 |
| Air 27°C/Water 27°C/Humidity 80% | | |
| Perfect Mode | | |
| Heating Capacity (kW) | 13.4 | 17.5 |
| COP | 15-7 | 15.5-7.4 |
| Average COP | 11.1 | 11.8 |
| Power Mode | | |
| Heating Capacity (kW) | 17 | 22 |
| Air 15°C/Water 26°C/Humidity 70% | | |
| Perfect Mode | | |
| Heating Capacity (kW) | 9.2 | 12.4 |
| COP | 7.8-5.0 | 8.2-5.1 |
| Average COP | 6.5 | 7 |
| Power Mode | | |
| Heating Capacity (kW) | 11.5 | 15 |
| Technical Specifications | | |
| Compressor | Twin Rotary DC | Twin Rotary DC |
| Fan Motor | Turbo Fan | Turbo Fan |
| Casing | Aluminium-alloy casing | Aluminium-alloy casing |
| Power Supply | 230V | 230V |
| Rated input power (kW) | 0.36-2.67 | 0.45-3.33 |
| Input power at 50% speed (kW) | 0.71 | 0.89 |
| Rated input current (A) | 1.57-11.63 | 1.96-14.49 |
| Sound level @ 1m db(A) | 39.3-46.7 | 39.5-49.8 |
| Sound level 50% @ 1m db(A) | 42.2 | 43.1 |
| Sound level @ 10m db(A) | 19.3-26.7 | 19.5-29.8 |
| Advised water flux (m³/h) | 4 to 6 | 6 to 9 |
| Water connection (mm) | 50 | 50 |



DC twin-rotary Inverter compressor of Mitsubishi



EEV technology: 10 times flexibility to adjust the gas flow and increase COP by up to 20%.



32% GWP comparing to R410A
25% CO2 carbon consumption
25% quota cost



Hot gas defrosting with Saginomiya 4 way valve for quick and efficient defrosting.



Twisted titanium heat exchanger: 40% higher efficiency than normal titanium heat exchanger.



Operate in air temp down to -15°C

BWT HPF PEARL INVERTER POOL HEAT PUMP



AVAILABLE IN

| KW | PRODUCT CODE |
|------|--------------|
| 9KW | BWTHPFO9 |
| 13KW | BWTHPF13 |
| 16KW | BWTHPF16 |
| 20KW | BWTHPF20 |
| 24KW | BWTHPF24 |
| 28KW | BWTHPF28 |

PRODUCT OVERVIEW

The most intuitive, intelligent and efficient pool heat pump on the market.

- Simple and intuitive operation and optimal performance.
- Built in connection with BWT Pearl Connect app (available on App Store / Play Store) for smart phone management and control.
- Low noise levels.
- Energy efficient in 3 operating modes; max, eco, silent.
- 3 year initial product warranty + 2 years if the product is registered to PolyConnect.

TECHNICAL PARAMETERS

| MODELS | BWT PEARL HPF09 | BWT PEARL HPF13 | BWT PEARL HPF16 | BWT PEARL HPF20 | BWT PEARL HPF24 | BWT PEARL HPF28 |
|--------------------------------|---------------------|---------------------|---------------------|----------------------|-----------------------|-----------------------|
| Pool size guide | 30-45m ³ | 55-70m ³ | 70-85m ³ | 85-105m ³ | 105-130m ³ | 130-160m ³ |
| Air 28°C / Water 28°C / 80% HR | | | | | | |
| Capacity in MAX Mode | 9,3 kW | 13,1 kW | 16,1 kW | 20,4 kW | 24,2 kW | 27,8 kW |
| COP MAX Mode | 6,5 - 5,5 | 5,6 | 5,1 | 5,2 | 5,4 | 5,2 |
| Capacity in ECO Mode | 8,8 - 3,5 kW | 13,1 - 4,2 kW | 16,1 kW - 5,5 kW | 20,4 - 6,5 kW | 24,2 - 7,8 kW | 27,8 - 10,5 kW |
| COP ECO Mode | 10,8 - 5,5 | 11,2 - 5,6 | 10,8 - 5,1 | 10,1 - 5,2 | 10,8 - 5,4 | 10,1 - 5,2 |
| Capacity in SILENT Mode | 5,8 - 3,5 kW | 4,2 kW | 5,5 kW | 6,5 kW | 7,8 kW | 10,5 kW |
| COP SILENT Mode | 10,8 - 8,3 | 11,2 | 10,8 | 10,1 | 10,8 | 10,1 |
| Air 15°C / Water 26°C / 70% HR | | | | | | |
| Capacity in MAX Mode | 6,6 kW | 9,8 kW | 11,5 kW | 14,8 kW | 18,2 kW | 22,8 kW |
| COP MAX Mode | 5,3 | 4,7 | 4,4 | 4,5 | 4,4 | 4,2 |
| Capacity in ECO Mode | 6,6 - 3,2 kW | 9,8 - 3,7 kW | 11,5 - 4,2 kW | 14,8 - 4,9 kW | 18,2 - 6,8 kW | 22,8 - 8,1 kW |
| COP ECO Mode | 6,7 - 5,6 | 7,0 - 4,7 | 6,7 - 4,4 | 6,6 - 4,5 | 6,7 - 4,4 | 6,5 - 4,2 |
| Capacity in SILENT Mode | 3,8 - 3,2 kW | 3,7 kW | 4,2 kW | 4,9 kW | 6,8 kW | 8,1 kW |
| COP SILENT Mode | 6,7 - 5,6 | 7 | 6,7 | 6,6 | 6,7 | 6,5 |
| Noise levels (min-max) | 21 - 25 dB(a) | 23 - 28 dB(a) | 25 - 30 dB(a) | 25 - 30 dB(a) | 26 - 31 dB(a) | 26 - 32 dB(a) |



BWT HPT PEARL INVERTER POOL HEAT PUMP

AVAILABLE IN

| KW | PRODUCT CODE |
|------|--------------|
| 9KW | BWTHPT09 |
| 15KW | BWTHPT15 |
| 20KW | BWTHPT20 |

PRODUCT OVERVIEW

The most intuitive, intelligent and efficient pool heat pump on the market.

- Simple and intuitive operation and optimal performance.
- Built in connection with BWT Pearl Connect app (available on App Store / Play Store) for smart phone management and control.
- Low noise levels.
- Energy efficient in 3 operating modes; max, eco, silent.
- 3 year initial product warranty + 2 years if the product is registered to PolyConnect.

TECHNICAL PARAMETERS

| MODELS | BWT PEARL HPT09 | BWT PEARL HPT15 | BWT PEARL HPT20 |
|--------------------------------|---------------------|---------------------|----------------------|
| Pool size guide | 30-45m ² | 55-70m ² | 85-105m ² |
| Air 28°C / Water 28°C / 80% HR | | | |
| Capacity in MAX Mode | 9,5 kW | 15,3 kW | 20,1 kW |
| COP MAX Mode | 6,3 | 6,3 | 6,1 |
| Capacity in ECO Mode | 9,5 - 3,2 kW | 15,3 - 3,9 kW | 20,1 - 5,5 kW |
| COP ECO Mode | 10,8 - 6,3 | 10,8 - 6,3 | 10,8 - 6,1 |
| Capacity in SILENT Mode | 3,2 kW | 3,9 kW | 5,5 kW |
| COP SILENT Mode | 10,8 | 10,8 | 10,8 |
| Air 15°C / Water 26°C / 70% HR | | | |
| Capacity in MAX Mode | 6,9 kW | 11,0 kW | 14,5 kW |
| COP MAX Mode | 4,7 | 4,7 | 4,5 |
| Capacity in ECO Mode | 6,9 - 3,5 kW | 11,0 - 5,0 kW | 14,5 - 7,0 kW |
| COP ECO Mode | 6,6 - 4,7 | 7,7 - 4,7 | 7,9 - 4,5 |
| Capacity in SILENT Mode | 3,5 | 5,0 kW | 7,0 kW |
| COP SILENT Mode | 6,4 | 6,5 | 6,6 |
| Noise levels (min-max) | 19 - 28 dB(a) | 21 - 30 dB(a) | 23 - 32 dB(a) |



BWT MINI CONNECT 4.3KW

PRODUCT
CODE

BWTHPM25

PRODUCT OVERVIEW

The mini heat pump from BWT is ideal for heating smaller above-ground pools and spas with a water content of up from 15 m³ to 25 m³. The heat pump is particularly compact and easy to operate. This allows the pool water to be tempered as desired and the bathing season to be extended.

- **PRACTICAL & COMPACT:** Small heat pump with small footprint, user-friendly and easy operation, simply connects to the house power
- **HEATING PERFORMANCE:** Max. Heat output 4.3 kW, ideal for above ground pools and spas between 15 and 25 m³
- **HIGH QUALITY COOLANT:** Environmentally friendly & efficient R32 coolant

TECHNICAL PARAMETERS

| BWT Mini Connect 25 | |
|---|------------------------|
| Recommended Pool Size | 15 - 25 m ³ |
| Air 26 ° C / Water 26 ° / 80% HR | |
| Energy Output BOOST mode | 4.3 kW |
| COP BOOST mode | 5.3 |
| Air 15 ° C / Water 26 ° / 70% HR | |
| Energy Output BOOST mode | 3.1 kW |
| COP BOOST mode | 4.5 |
| Air 7 ° C / Water 26 ° / 90% HR | |
| Energy Output BOOST mode | 2.4 kW |
| COP BOOST mode | 2.5 |
| Noise Levels | 35 db(A) |
| Minimum water flow | 2 m ³ /h |
| Pressure drop | 16 kPa |
| Dimensions (l x w x h) | 430x290x375mm |
| Net weight | 23.8 kg |





BWT STEPIO SPA HEAT PUMP 6.5 KW

PRODUCT
 CODE

BWTHPSTEP

PRODUCT OVERVIEW

The Stepio Spa Heat Pump by BWT features discrete and compact design made to fit underneath the steps of a spa pool. This unit ensures consistent heating of the spa pool at 38 degrees. Energy efficient with full inverter technology, low noise levels as it automatically adjusts the rotation speed of the compressor and fan to reduce noise to the minimum, simple, intuitive and completely automated via the BWT Connect App on your smartphone.

TECHNICAL PARAMETERS

| | |
|------------------------|----------------------------------|
| | <i>Air 28°C/Water 38°C/80%HR</i> |
| Energy Output | 6.5 kW |
| COP | 4.6 |
| | <i>Air 15°C/Water 38°C/70%HR</i> |
| Energy Output | 4.4 kW |
| COP | 3.4 |
| | <i>Air 15°C/Water 26°C/0%HR</i> |
| Energy Output | 5.2 kW |
| COP | 4.6 |
| | <i>Air -10°C/Water 38°C/0%HR</i> |
| Energy Output | 1.1 kW |
| COP | 0.9 |
| Noise level (10m) | 29 db(A) |
| Temp. working range | - 10°C up to 38°C |
| Compressor | 2D Full DC Inverter |
| Expansion valve | Electronic |
| Exchanger | Coiled titanium |
| Housing | UV resistant ABS housing panels |
| Refrigerant | R32 |
| Hydraulic connection | 50mm |
| Power | 230V |
| Max. intensity | 6.2A |
| Min. water flow | 3m ³ /h |
| Dimensions (l x w x h) | 750 x 375 x 490 mm |
| Weight (net) | 47 kg |





BWT CRYO INVERTER HEAT PUMP 4KW

PRODUCT
CODE

BWTHPCRYO

PRODUCT OVERVIEW

The Cryo Inverter is specifically designed to cool down water to 5 degrees Celsius for cryotherapy applications and cold water therapy purposes. Thanks to the Full-Inverter technology, the CRYO PAC adjusts its operation according to the pool requirements, giving peace of mind, extension of the equipment's lifespan and 30% energy savings compared to a standard heat pump. Conventional installation, like a standard pool heat pump.

TECHNICAL PARAMETERS

| Air 32°C/Water 5°C | |
|------------------------|--------------------|
| Energy Output | 4 kW |
| Energy Input | 1.0 kW |
| Energy Efficient Ratio | 2.65 |
| Noise levels | 28 - 32 db(A) |
| Temp. working range | - 10°C up to 35°C |
| Components | |
| Compressor | Inverter |
| Refrigerant | R32 |
| Installation | |
| Hydraulic connection | 50mm |
| Power | 230V |
| Max. intensity | 6.3A |
| Min. water flow | 4m ³ /h |
| Dimensions (l x w x h) | 936 x 322 x 567 mm |
| Weight (net) | 33 kg |





SALT CHLORINATORS & POOL AUTOMATION

INVERTER SALT POOL SOLUTIONS.



INTRODUCING THE AQUARK MR. PURE

INVERTURBO TECHNOLOGY adopts an advanced PID algorithm for accurate control of chlorine production and pH regulation. With self-adaptation to different situations, INVERTURBO TECH achieves high performance at low salt levels down to 1g/L and guarantees no additional salt maintenance for 180 days.

POOL & SPA EQUIPMENT
SALT CHLORINATORS



**AQUARK MR. PURE
INVERTER SALT CHLORINATOR**
AVAILABLE IN

| MODEL | PRODUCT CODE |
|------------|-------------------|
| 14G | QASCMPS14P |
| 22G | QASCMPS22P |
| 34G | QASCMPS34P |

PRODUCT OVERVIEW

SEE' the real-time water quality on the pad controller easily, even if you have no idea about chemistry. Thanks to INVERTURBO TECH, say goodbye to the hassle of adding salt. With no additional salt maintenance needed for 180 days, users can enjoy a totally hands-free pool experience all season long. Fully automated and controlled through smartphone application for ease of access.

- ORP/pH/Temperature Reading
- One-click Turbo/Boost
- Salinity Reference
- Logs Review
- Mineral Salt Compatible

TECHNICAL PARAMETERS

| Model | MPS14 | MPS22 | MPS34 |
|---|---|-------------|-------------|
| Production at 130%(g/h, 3000PPM) | 14.0 | 22.0 | 34.0 |
| Production at 130%(g/h, 1000PPM) | 7.0 | 12.0 | 19.0 |
| Production at 100%(g/h, 3000PPM) | 11.0 | 17.0 | 26.0 |
| Salt Level (g/L) | 1 ~ 5 (recommended 3g/L) | | |
| Advised pool volume (m3) (at 1800PPM) | 20-35 | 35-50 | 50-90 |
| TECHNICAL SPECIFICATIONS | | | |
| Advised water flux (m³/h) | 5 ~ 20 | 5 ~ 20 | 5 ~ 20 |
| Power Supply | 100~240V 50/60Hz | | |
| Power Consumption (W) | 80 | 115 | 140 |
| Output (A) | 5.9 | 7 | 10 |
| Voltage(V) | 12 | | |
| Operating Temperature (°C) | -5 ~ 42 °C | | |
| Salinity Test | Salt Level Detection (accuracy ±500PPM) | | |
| Self-cleaning | Default 4h, 3 options in total (2/4/6h) | | |
| Dosing Pump | Built-in/Integrated | | |
| Communications | MODBUS RS485 / Wi-Fi / Dry Contact | | |
| Control Unit Dimension LxWxH (mm) | 202 x 270 x 75 | | |
| ELECTROLYSIS CELL | | | |
| Water connection (mm) | 63/60.3/50/48.3 | | |
| Water Temperature | 10 ~ 40 °C | | |
| Maximum Pressure | 3 Bar | | |
| Cell Life(h) | 10,000 | | |
| Cell Dimension LxWxH (mm) | 458×104×272 | 458×104×272 | 458×104×272 |
| PACKAGING SPECIFICATIONS | | | |
| Net Weight (kg) | 7 | 7 | 7 |
| Gross Weight (kg) | 9 | 9 | 9 |
| Packaging Dimension LxWxH (mm) | 550 x 400 x 300 | | |
| Qty per 20'FT/40'HQ (sets) | 364/896 | | |



ONE-CLICK SIMPLICITY
App control is enabled to keep you well informed of real-time water reports:

- ORP/pH/Temperature Reading
- One-click Turbo/Boost
- Salinity Reference
- Logs Review



LINCOLN LSC SALT CHLORINATOR

AVAILABLE IN

MODEL

20G
30G
50G

PRODUCT CODE

SPLESC20
SPLESC30
SPLESC50

PRODUCT OVERVIEW

The Lincoln chlorinator range features an easy to use menu and a smart micro-computer controller system. It precisely adjusts chlorine output to 1% and includes an automatic self-cleaning feature.

Features:

- Easy to use menu
- High salt/mineral indicator
- Smart micro-computer controller system
- Precision adjustment of chlorine output to 1%
- Auto-pilot mode
- Automatic power reduction when salt or mineral level is too high
- Automatic self cleaning on all models
- Run dry pump protection • Water temperature reading
- Salt/mineral level test function

TECHNICAL PARAMETERS

| Model | Chlorine production grams/hour | Max pool size |
|----------|--------------------------------|---------------|
| SPLESC20 | 20 | 55,000L |
| SPLESC30 | 30 | 75,000L |
| SPLESC50 | 50 | 120,000L |

***75g and 100g models are available on request.**



LINCOLN ECO SERIES SALT CHLORINATOR 20G

PRODUCT
CODE
SPLESC-ECO20

PRODUCT OVERVIEW

Auto self cleaning. Suitable for Mineral, Magnesium & Sodium Salt pools.
Recommended 3500 - 4000PPM.

- Easy to operate Analog Timer complete with internal re-charging Ni-Mh battery backup
- Self cleaning cell
- Automatic safety power reduction when salt high
- Proven high quality cell material
- 10 Increment LED display for accurate chlorine control
- Smart embedded micro-controller
- Works with any 230/240V Pump
- Stainless grade 304 mounting bracket with quick release pins
- Suitable for installation outdoors IP34 rated
- For pools between 35-55 m³



LIFE JUST GOT EASIER WITH AQUATEK.



INTRODUCING THE AQUATEK POOL AUTOMATION CONTROLLER.

The AQUATEK controller is the first agnostic pool controller which efficiently manages your pool, spa and heating requirements via WiFi. By simply downloading the AQUATEK app on any smartphone, AQUATEK uses Wi-Fi to effortlessly control multiple pool and spa requirements.



AQUATEK POOL AUTOMATION CONTROLLER

AVAILABLE IN

TYPE

POOL/SPA WI-FI CONTROLLER
POOL/SPA WI-FI EXPANSION CONTROLLER 10AMP
POOL/SPA WI-FI EXPANSION CONTROLLER 15AMP

PRODUCT CODE

SP01DT
SP02DT
SP03DT

PRODUCT OVERVIEW

Control your pool from the palm of your hand and say goodbye to complicated pool automation. Simply download the AQUATEK app on your smartphone. AQUATEK uses state of the art technology and manages all your pool and spa requirements. It also has the capacity to have an additional 2 expansion units connected to it, with each one having an additional 3, 240VAC output sockets controlled via the AQUATEK controller. Up to an additional 6 power sockets can be utilised and controlled by the AQUATEK master controller.

AQUATEK can control:

single speed pumps, variable speed pumps, sanitiser, heater, solar heating, lights, water feature, pool/spa valve actuators, and all spa equipment requirements.

YOUR PERSONAL POOL AUTOMATION MANAGER.

INTRODUCING THE BWT EASYDOSE RANGE.

The EasyDose range of peristaltic pumps allows for automated dosing of chemicals for your pool. No need for weekly tests, treatment chemicals are injected automatically without any intervention by the user. Optimal, efficient and economical.



BWT EASYDOSE PERISTALTIC PUMPS

AVAILABLE IN

TYPE

PH +/- AUTO MANAGER
ORP AUTO MANAGER

PRODUCT CODE

BWTMC5204
BWTMC5205

TECHNICAL PARAMETERS

| | pH Auto Manager | ORP Auto Manager |
|------------------------|----------------------|----------------------|
| Pool Volume | 5-130m ³ | 5-130m ³ |
| Flow Rate | 1.5L/h at 1.5 bar | 1.5L/h at 1.5 bar |
| Power Supply | 230VAC - 50/60 Hz 9W | 230VAC - 50/60 Hz 9W |
| Weight | 950g | 950g |
| Measurement Scale | 3.8 - 8.2 pH | 400 - 900 mV |
| Measurement Precision | ± 0.1 pH | ± 10 mV |
| Ambient Temperature | 10 - 50 °C | 10 - 50 °C |
| Display | High visibility LED | High visibility LED |
| Sensor Technology | pH sensor | ORP sensor |
| Dimensions(w/h/d) (mm) | 89 x 138 x 118 | 89 x 138 x 118 |



AQUAGEM

POOL & SPA PUMPS



THE WORLD'S FIRST FULL INVERTER POOL PUMP.



INTRODUCING THE AQUAGEM INVERPRO

Combining full inverter technology, volute hydraulic system and DC brushless motor. It intelligently runs at 30-100% capacity for various applications like filtration and backwash. Additionally, it reduces sound levels over 30 times and saves energy up to 15 times compared to a regular pool pump.



Full Inverter technology



Volute hydraulic system



DC brushless motor





AQUAGEM INVERPRO FULL INVERTER POOL PUMP

AVAILABLE IN

| HP | PRODUCT CODE |
|--------|--------------|
| 1 HP | QGVPIP20 |
| 1.5 HP | QGVPIP25 |
| 2 HP | QGVPIP30 |

PERFORMANCE CURVE

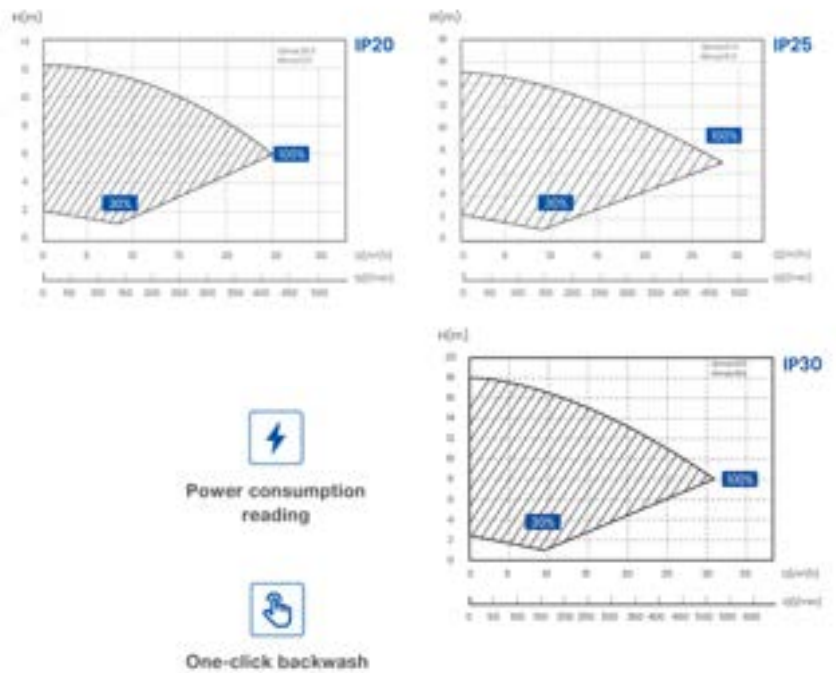

PRODUCT OVERVIEW

- Full Inverter by InverSilence® Tech
 - Up to 15x more energy efficient *
 - Up to 30x more silent *
 - Power Consumption Reading
 - Intelligent Full Touch Controller
- *comparison is based on traditional pool pumps

| | | |
|---------------------------------------|------------------|------------------------------|
| | | |
| AUTO/MANUAL inverter mode optional | External control | Power consumption reading |
| | | |
| WiFi optional | Flow reading | One-click backwash |

TECHNICAL PARAMETERS

| Model | Pool volume m³ | P1 (kW) | Voltage (V/Hz) | Qmax | Hmax | Circulation Flow (m³/h) 30%-100% |
|-------|----------------|-----------|----------------|------|------|----------------------------------|
| IP20 | 30-50 | 0.07-0.77 | 220-240/50/60 | 25 | 12.5 | 4.5-15 |
| IP25 | 40-70 | 0.08-1.05 | 220-240/50/60 | 27.5 | 15 | 6.6-22 |
| IP30 | 50-80 | 0.09-1.40 | 220-240/50/60 | 31 | 18 | 8.1-27 |

ALPHA DUAL SPEED POOL PUMP 0.25/1.5 HP

PRODUCT
CODE
BBPA0215



PRODUCT OVERVIEW

The Alpha Dual Speed Pool Pump boasts a stainless steel shaft and a glass-filled poly-propylene construction with high UV protection, ensuring strength and longevity. The pump features a carbon ceramic mechanical seal and top-notch bearings sourced from TPI-Taiwan, guaranteeing reliable performance. With a large leaf basket and clear view lid, maintenance is effortless. The pump comes with fitting unions in both 40mm and 50mm sizes, along with a 1.5m suction end on high speed. It's ready to go with a 3m flex and a built-in overload thermal protector made in the USA for added safety. Meeting IP55 water ingress standards, this pump is built to withstand demanding conditions. Operating at a single phase of 240V/50Hz, it handles water temperatures below 35°C and ambient temperatures below 50°C. Compliance with AS/NZS60335.1 & AS/NZS60335.2.41 standards ensures quality and reliability. Equipped with a high speed/low speed switch, this pump offers versatility. With a 3-year domestic warranty (including a 2-year Mechanical Seal warranty and 1-year commercial warranty), you can trust in its performance and durability.

PERFORMANCE CURVE

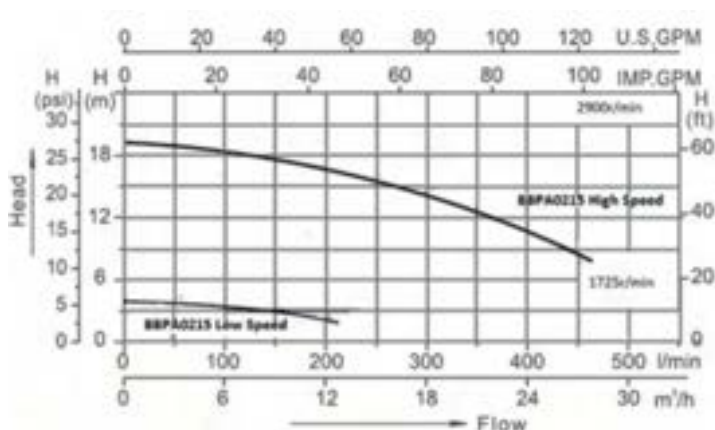

TECHNICAL PARAMETERS

| Max Head (m) | max Lpm | Input kW | Output kW |
|--------------|---------|---------------------|-------------|
| 19 | 465 | 0.135/1.5 | 0.25/1.1 |
| Output HP | Amps | Size mm (l x w x h) | Weight (kg) |
| 0.25/1.5 | 2.4/7.0 | 628x240x320 | 19.5 |



PRODUCT OVERVIEW

The Bravo Single Speed Pool Pump is designed with features specifically tailored for both fresh and salt pools. It includes a stainless steel shaft and glass filled poly-propylene construction with high UV protection for strength and durability. The carbon ceramic mechanical seal ensures reliable performance. The pump is equipped with top-quality bearings sourced from TPI-Taiwan and features a large leaf basket with a clear view lid for easy maintenance. It comes with 40mm and 50mm fitting unions, a 1.5m suction end on high speed, and a ready-to-go plug with a 3m flex. The built-in overload thermal protector, made in the USA, enhances safety. With IP55 water ingress protection and compliance with AS/NZS60335.1 & AS/NZS60335.2.41 standards, this pump is built to last. Operating at a single phase of 240V/50Hz and suitable for temperatures below 35°C for water and 50°C for the ambient environment. We offer a 3-year domestic warranty, including a 2-year Mechanical Seal warranty and 1-year commercial warranty.

BRAVO SINGLE SPEED POOL PUMP

AVAILABLE IN

| HP | PRODUCT CODE |
|---------|--------------|
| 0.75 HP | BBPB07 |
| 1 HP | BBPB10 |
| 1.5 HP | BBPB15 |
| 2 HP | BBPB20 |
| 2.5 HP | BBPB25 |

PERFORMANCE CURVE

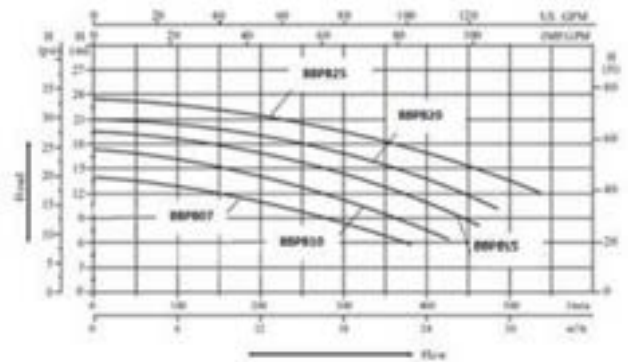

TECHNICAL PARAMETERS

| model code | max Head(m) | max Lpm | input kW | output kW | output HP | amps | size LxWxH | weight (kg) |
|------------|-------------|---------|----------|-----------|-----------|------|-------------|-------------|
| BBPB07 | 14.5 | 340.0 | 0.75 | 0.55 | 0.75 | 3.8 | 593x240x320 | 13.5 |
| BBPB10 | 17.0 | 420.0 | 1.10 | 0.75 | 1.0 | 5.2 | 593x240x320 | 15.5 |
| BBPB15 | 19.0 | 465.0 | 1.50 | 1.10 | 1.5 | 7.0 | 593x240x320 | 17.5 |
| BBPB20 | 21.0 | 480.0 | 1.85 | 1.50 | 2.0 | 8.6 | 593x240x320 | 18.5 |
| BBPB25 | 23.0 | 540.0 | 2.20 | 1.85 | 2.5 | 10.0 | 609x240x320 | 20.0 |



LIGHT DUTY POOL PUMPS

AVAILABLE IN

| HP | PRODUCT CODE |
|---------------|-----------------|
| 0.25HP | BBPH0.25 |
| 0.33HP | BBPH0.33 |
| 0.7HP | BBPH07 |
| 1 HP | BBPH10 |

PRODUCT OVERVIEW

- Light duty, entry level pool pump designed for above ground pools
- Quiet operation
- Inner and outer thread design
- Liquid temperature <60°C
- Can resist chemical in swimming pool
- IPX5
- Anodised motor body
- Overload protection
- Huge pro-filter for less cleaning maintenance
- Heightened pump base to keep off of water or moist environment



DELTA DUAL SPEED SPA PUMP 0.3/2.0 HP

PRODUCT
CODE
BBSD0320



PRODUCT OVERVIEW

The Delta Dual Speed Spa Pump features a nickel-plated #45 steel shaft for added durability. Its glass-filled poly-propylene construction provides exceptional strength and high UV protection. The pump is equipped with a reliable carbon ceramic mechanical seal and top-quality bearings sourced from TPI-Taiwan. With 50mm fitting unions, installation is a breeze. The built-in overload thermal protector, made in the USA, ensures safety and peace of mind. Meeting IP55 water ingress standards, this pump is designed for durability and longevity. Operating at a single phase of 240V/50Hz, it can handle water temperatures below 40°C and ambient temperatures below 50°C. Compliance with AS/NZS60335.1 & AS/NZS60335.2.41 standards guarantees its quality and performance. We offer a 1-year domestic warranty, including a 6-month warranty for the mechanical seal and commercial use.

PERFORMANCE CURVE

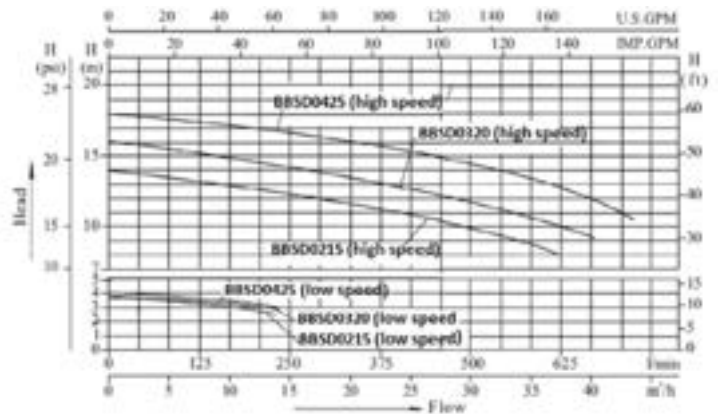

TECHNICAL PARAMETERS

| Max Head (m) | max Lpm | Input kW | Output kW |
|--------------|---------|------------------|-------------|
| 16 | 670 | 0.4/1.85 | 0.26/1.5 |
| Output HP | Amps | Size (l x w x h) | Weight (kg) |
| 0.3/2.0 | 9 | 434x202x197 | 17 |



ECHO SINGLE SPEED SPA PUMP

AVAILABLE IN

| HP | PRODUCT CODE |
|--------|--------------|
| 1.1 HP | BBSE11 |
| 1.5 HP | BBSE15 |
| 2 HP | BBSE20 |
| 2.5 HP | BBSE25 |

PRODUCT OVERVIEW

The Echo Single Speed Spa Pump featuring a nickel-plated #45 steel shaft for exceptional durability. Its glass-filled poly-propylene construction ensures strength and high UV protection. Equipped with a reliable carbon ceramic mechanical seal and top-quality bearings sourced from TPI-Taiwan, this pump delivers reliable performance. With 50mm fitting unions, installation is quick and easy. The built-in overload thermal protector, made in the USA, offers added safety. Meeting IP55 water ingress standards, this pump is built to withstand various conditions. Operating at a single phase of 240V/50Hz, it maintains optimal performance in water temperatures below 40°C and ambient temperatures below 50°C. Compliant with AS/NZS60335.1 & AS/NZS60335.2.41 standards, this pump ensures quality and reliability. We provide a 1-year domestic warranty, including a 6-month warranty for the mechanical seal and commercial use.

PERFORMANCE CURVE

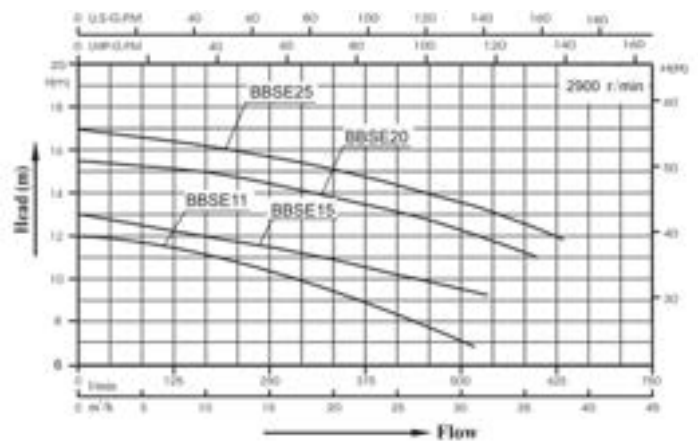

TECHNICAL PARAMETERS

| model code | max Head(m) | max Lpm | input kW | output kW | output HP | amps | size LxWxH | weight (kg) |
|------------|-------------|---------|----------|-----------|-----------|------|-------------|-------------|
| BBSE11 | 12 | 520 | 1.1 | 0.75 | 1.0 | 5.8 | 382x202x218 | 12 |
| BBSE15 | 13 | 535 | 1.5 | 1.1 | 1.5 | 7.0 | 382x202x218 | 12.7 |
| BBSE20 | 15.5 | 600.0 | 1.85 | 1.50 | 2.0 | 8.0 | 382x202x218 | 14.6 |
| BBSE25 | 17.0 | 635.0 | 2.20 | 1.85 | 2.5 | 10.0 | 397x202x218 | 16.3 |



FOX SINGLE SPEED SPA PUMP

AVAILABLE IN

| HP | PRODUCT CODE |
|---------|--------------|
| 0.25 HP | BBSF02 |
| 0.35 HP | BBSF03 |
| 0.5 HP | BBSF05 |
| 1 HP | BBSF10 |

PRODUCT OVERVIEW

Discover the Fox Spa Pump with durability and performance in mind. It features a nickel-plated #45 steel shaft for exceptional strength. The glass-filled polypropylene construction offers superior UV protection. With a reliable carbon ceramic mechanical seal and top-notch bearings sourced from TPI-Taiwan, this pump ensures reliable operation. The 50mm fitting unions make installation quick and hassle-free. The built-in overload thermal protector, made in the USA, enhances safety. Meeting IP55 water ingress standards, this pump is designed to withstand demanding conditions. Operating at a single phase of 240V/50Hz, it performs optimally in water temperatures below 40°C and ambient temperatures below 50°C. Complying with AS/NZS60335.1 & AS/NZS60335.2.41 standards, this pump guarantees quality and reliability. We provide a 1-year domestic warranty, including a 6-month warranty for the mechanical seal and commercial use.

PERFORMANCE CURVE

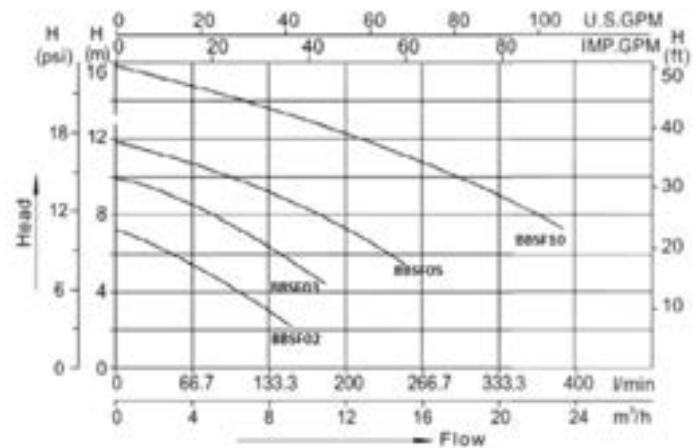

TECHNICAL PARAMETERS

| model code | max Head(m) | max Lpm | input kW | output kW | output HP | amps | size LxWxH | weight (kg) |
|------------|-------------|---------|----------|-----------|-----------|------|-------------|-------------|
| BBSF02 | 7.5 | 150 | 0.25 | 0.19 | 0.25 | 1.6 | 317x153x191 | 5.1 |
| BBSF03 | 10.0 | 180.0 | 0.37 | 0.26 | 0.35 | 2.0 | 317x153x191 | 5.9 |
| BBSF05 | 12.0 | 250.0 | 0.55 | 0.37 | 0.5 | 3.2 | 347x156x205 | 7.9 |
| BBSF10 | 13.0 | 335.0 | 0.9 | 0.75 | 1.0 | 4.6 | 347x156x205 | 9.1 |

SPA POOL CIRCULATION PUMP 250-WATT

PRODUCT
CODE
BBWTC50M



PRODUCT OVERVIEW

Our versatile spa circulation pump is designed for both Hydro Massage Tubs or Spa Systems and swimming pool circulation or filtration. With a P1 input of 0.25 KW / 1/3hp and a P2 output of 0.25hp, it delivers efficient performance. The pump comes with 2 x 48.5 union fittings for easy installation. It includes a 3mtr flex with an Amphenol plug, ensuring convenience.

Operating Conditions:

- Medium Temperature: 5-50°C
- Environmental Temperature: ≤50°C
- Maximum Working Pressure: 0.3MPa

This pump is engineered to handle a wide range of applications and provides reliable performance in various working conditions.

PERFORMANCE CURVE

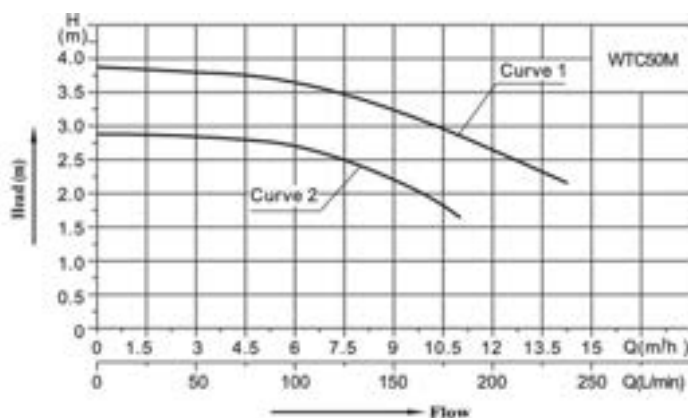

TECHNICAL PARAMETERS

| V/HZ | Speed (rpm) | Power (kW/HP) | Amps |
|--------------|-------------|------------------|-------------|
| 230/50 | 1400 | 0.25/0.35 | 1 |
| Qmax (L/min) | Hmax (m) | Size (l x w x h) | Weight (kg) |
| 240 | 3.8 | 320x180x210 | 6 |

SPA AIR BLOWERS



BBAPR400-V2

- 400 watt
- 40mm union 1.5m flex and Amphenol plug without heater



BBAPR700-V2

- 700 watt
- 40mm union 1.5m flex and Amphenol plug without heater



BBAPR900-V2

- 900 watt
- 40mm union 1.5m flex and Amphenol plug without heater



VIEW OUR FILTER CARTRIDGE CATALOGUE!

Space Industries offers a large variety of spa filter cartridges for different spa brands and models.

Browse our most recent catalogue via our website and contact us on reception@spaceindustries.co.nz for any inquiries and additional information.



SAND FILTERS & COMBO KITS





AQUAFINZ GLOSS FIBREGLASS SAND FILTER

AVAILABLE IN

| DIAMETER O/D | PRODUCT CODE |
|-----------------|-----------------|
| 550 | BBSF550 |
| 650 | BBSF650 |
| 750 | BBSF750 |

PRODUCT OVERVIEW

Our new Aquafinz Sand Filter with laminated fiberglass top mount filter is durable, corrosion-resistant and features a glossy finish in gel coat for a smooth and beautiful exterior. This collection of sand filters is the perfect choice for high-end villas and hotel pools, high-class spas and wellness pools, baths and fish ponds.

- Non corrosive gel coat fiberglass tank, smooth gloss finish.
- Equipped with a 1.5" or 2.0" six-position multiport valve.
- Universal standard of union connection provided.
- Max. working pressure 36 psi/2.5 bar.
- Max. temperature of 43°C(109°F)
- Suggested size of media: 0.5–0.8mm.

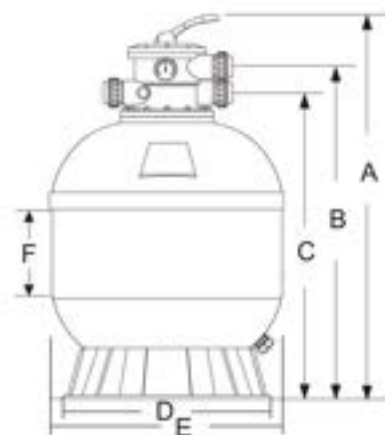

TECHNICAL PARAMETERS

| Model | Max flow rate | | Filter area m ² | Port size | | Sand kg | Dimension(mm) | | | | | |
|------------------------------|---------------|-------------------|-------------------------------|-----------|----|------------|---------------|------|-----|-----|-----|-----|
| | lpm | m ³ /h | | inch | mm | | A | B | C | D | E | F |
| Multiport valve W 1.5 | | | | | | | | | | | | |
| L550 | 167 | 10.00 | 0.20 | 1.5" | 50 | 88 | 886 | 750 | 690 | 390 | 530 | 286 |
| L650 | 275 | 16.50 | 0.33 | 1.5" | 50 | 158 | 1000 | 850 | 790 | 500 | 640 | 318 |
| Multiport valve W 2.0 | | | | | | | | | | | | |
| L750 | 366 | 22.00 | 0.44 | 2" | 63 | 260 | 1170 | 1005 | 920 | 710 | 750 | 390 |



BLUEY FIBREGLASS SAND FILTER KITS

AVAILABLE IN

| DIAMETER O/D | PRODUCT CODE |
|--------------|--------------|
| 525 | BBSF500 |
| 625 | BBSF600 |
| 700 | BBSF700 |

PRODUCT OVERVIEW

Removing unwanted additions to your pool is critical to pool health. You need a filter that can not only retain this washout from filtration but handle the high pressure action of a good pump. Bluey filters are solid wound fibreglass. They are UV & chemical resistant and handle up to 36psi.2.5bar.

Every Bluey comes standard with a 6 position Multi port valve with sight glass and SS pressure gauge.

Ideal for use on any sort of pool regardless of whether fresh or salt water.

Warranty - 5years on parts. (Excludes spider valve seal)

TECHNICAL PARAMETERS

| Code | Description | Suits pools up to (ltr) | Valve (mm) | Max Flow (l/pm) | Filter Area (m²) | Height | Diameter (O/D) | Pool Sand (kg) |
|---------|------------------------------------|-------------------------|------------|-----------------|------------------|--------|----------------|----------------|
| BBSF500 | Bad Boy Fiberglass Sand Filter 525 | 56,000 | 40 | 190 | 0.22 | 880 | 525 | 85 |
| BBSF600 | Bad Boy Fiberglass Sand Filter 625 | 81,000 | 40 | 270 | 0.3 | 1005 | 625 | 150 |
| BBSF700 | Bad Boy Fiberglass Sand Filter 700 | 110,000 | 50 | 350 | 0.4 | 1150 | 700 | 200 |



POOL PUMP AND FILTER COMBO

AVAILABLE IN

| MM | WATTS | PRODUCT CODE |
|-----|-------|-----------------|
| 330 | 250 | BBPFCOMBO |
| 400 | 370 | BBPFCOMBOL |

PRODUCT OVERVIEW

SAA CERTIFIED

Includes Easy read instructions & diagrams, Filter, Plinth base Pump Jointing hose, Modular fittings to suit most pool brands.

BBPFCOMBO requires: 19kg of pool sand, for above ground pools up to 25,000L

BBPFCOMBOL requires: 30kg of pool sand, for above ground pools up to 40,000L



POOL PUMP AND FILTER COMBO 10KG/90W

PRODUCT
CODE
PSP90W

PRODUCT OVERVIEW

All in one simple ready-to-go option for small pools. This filter and pump combo will suit all above ground pools up to 27000L.

Water Flow: 3000L/HP: 90 watt/Voltage: AC220-240v/Pools with 32MM fittings

Fittings: Comes with fitting hoses and clamps to fit your 32mm drain points

Measurements: 37 X 32.5 X 58 Requires 10KG of sand. Comes with 12 months warranty.



WE SELL POOL SAND AND SALT!

Space Industries offers swimming pool salt and sand in bulk quantities. Feel free to contact us on (09) 262 3902 or email us on reception@spaceindustries.co.nz .



ABOVE GROUND POOL PUMP 60W

PRODUCT
CODE
PSP60W

PRODUCT OVERVIEW

Perfect for above ground pools and fits most brands of soft sided pools up to 20,000 L. 56L min flow rate is much stronger than conventional models. Comes with Cartridge filter with 50% more filter area than conventional models. Comes with replacement hoses and hose clamps. Comes with a 12 month consumer warranty.



WE SELL SPARE PARTS!

Space Industries offers spare parts for certain products and models. Feel free to contact us on **(09) 262 3902** or email us on **reception@spaceindustries.co.nz** .



POOL & SPA VACUUM CLEANERS





KOKIDO BOREAL EV01 SPA VACUUM

PRODUCT CODE: EV01CBX/SPA/AU

PRODUCT OVERVIEW

Ctn Qty: 4

- For spa pools
- 1.5m Maximum Operating Depth
- Cleans Spa Floor
- 30 Mins Of Battery Life
- 4-5 Hours Charging Time
- 0.1L Debris Capacity

KOKIDO TELSA EV05 SPA VACUUM

PRODUCT CODE: EVO5CBX/EU

PRODUCT OVERVIEW

Ctn Qty: 4

- For small pools
- 3m Maximum Operating Depth
- Cleans Pool Floors and Waterline
- 30 Mins Of Battery Life
- 4-5 Hours Charging Time
- 0.42L Debris Capacity



BWT PK SWIFT POOL VACUUM

PRODUCT CODE: EV35CBX/BWT/AU

PRODUCT OVERVIEW

Ctn Qty: 2

- For Medium-Sized Pools Up To 15 m³
- 3m Maximum Operating Depth
- Cleans Pool Floor And Walls
- 30 Mins Of Battery Life
- 5-6 Hours Charging Time
- 0.9L Dirt Collector Capacity





BWT PK GIANT POOL VACUUM

PRODUCT CODE: EV75CBX/BWT/AU

PRODUCT OVERVIEW

Ctn Qty: 1

- For Large Pools Up To 35 m³
- 3m Maximum Operating Depth
- Versatile On All Types Of Pools
- 75 Mins Of Battery Life
- 5-6 Hours Charging Time
- 3L Dirt Collector Capacity

Replacement filter cartridge twin pack available for purchase (EV75CBX/FILTERSX2)



BWT BC40 POOL LEAF EATER

PRODUCT CODE: EV40CBX/BWT/AU

PRODUCT OVERVIEW

Ctn Qty: 2

- For Large Pools Up To 25 m³
- 3m Maximum Operating Depth
- Perfect For Cleaning Leaves And Dirt In Pool
- 75 Mins Of Battery Life
- 5-6 Hours Charging Time
- 6.5L Dirt Collector Capacity



A photograph of a swimming pool at sunset. The sun is low on the horizon, creating a warm, golden glow over the water and the surrounding area. In the foreground, various pool maintenance tools are laid out on the pool deck, including a blue and white vacuum head, a long-handled brush, a blue and white skimmer, and a blue and white pump. A blue and white inflatable ring is floating in the pool. The background shows a building and trees.

CONSUMABLES



POOL & SPA EQUIPMENT
CONSUMABLES



**STANLEY DLX 18" FLEXIBLE
POOL BRUSH 45 CM**

ST20876

Ctn Qty: 12

Heavy duty, long lasting nylon bristles. Extra-wide body. Flexible curve design for superior functionality. Die-cast aluminium handle.



STANLEY DLX VINYL VAC

ST27812

Ctn Qty: 6

The Stanley Pooltec DLX Liner Vac Head is a heavy and solidly constructed vac head suited to most above ground pools. Uses standard telescopic pole fittings.



**STANLEY DLX ALUMINIUM
LEAF RAKE**

ST21177

Ctn Qty: 12

Aluminium inner frame with black polymer mark-resistant rim. Durable pocket screening made of close-mesh netting. Works with any 32mm diameter pole.



**STANLEY DLX ALUMINIUM
LEAF SKIMMER**

ST21180

Ctn Qty: 12

For removing surface leaves and debris from pool or spa. Durable pocket screening made of close-mesh netting. Mark-resistant polymer rim. Works with any standard 1¼ in (32mm) diameter pole.



STANLEY POOL DISPENSER

ST32855

Ctn Qty: 12

Provides consistent protection with continual amounts of chlorine. Automatic release eliminates day-to-day maintenance. Adjustable chlorinating ring. Holds up to 3 in (76mm) tablets or sticks.



STANLEY SPA DISPENSER

ST32857

Ctn Qty: 24

Provides consistent protection with continual amounts of sanitiser. Automatic release eliminates day-to-day maintenance. Adjustable chlorinating ring. Holds 1 in (25mm) pills.

POOL & SPA EQUIPMENT
CONSUMABLES



**STANLEY DLX
THERMOMETER**

ST25800

Ctn Qty: 12

Floating thermometer accurately measures water temperature. Removable snap-on float and polyethylene cord allows for use as a floating or submersible thermometer. Easy to read dual temperature scales. Shatter resistant lens.



STANLEY FLEX VACUUM

ST27809

Ctn Qty: 6

For removing debris from pools with hard-surface finish. The flexible body handles corners and other curves on the floor of the pool or spa. Works with any standard 32 mm diameter pole.



**VACUUM BRUSH FOR
VINYL POOLS**

VAB

Ctn Qty: 6

Ideal for deep pool cleaning. Fits all standard pool poles. Fits 38mm or 32mm hose types



**STANLEY 3.6M
TELESCOPIC POLE**

ST21813

Ctn Qty: 4

3.6m Swimming Pool Telescopic Pole. 32mm diameter to fit all NZ style pool equipment.



**STANLEY 4.9M
TELESCOPIC POLE**

ST21817

Ctn Qty: 12

4.9m Swimming Pool Telescopic Pole. 32mm diameter to fit all NZ style pool equipment.



TELESCOPIC POLES

**POL927 (2 X 240 CM)
POL120 (2 X 120 CM)
POL3 (3 X 1.1M)
POL180 (2 X 180 CM)
POLD240 (2 X 240 CM)**

Ctn Qty: 20

Standard telescopic pole to fit all NZ style pool equipment.

POOL & SPA EQUIPMENT
CONSUMABLES



**FLOATING DISPENSER
SMALL 20G**

FDS

Ctn Qty: 12

Expandable and adjustable. Takes 20g pills and holds up to 8 pills.



**FLOATING DISPENSER
LARGE 200G**

FDL

Ctn Qty: 6

Expandable and adjustable. Takes 200g tablets and holds up to 5 tablets.



**BOREAL FLOATING SPA
DISPENSER**

K676BU/SPA

Ctn Qty: 12

Floating spa dispenser for 38 mm / 1½ inch tablets. Holds up to 8 tablets.



**SEGMENTED HOSE
32 MM X 3M**

PSHOSE3

Ctn Qty: N/A

Segmented 32mm x 3m hose to replace above ground pool hoses. Can be cut at 1m intervals.



**HEAVY DUTY POOL HOSE
38 MM X 11 M**

HOS3811 HD

Ctn Qty: 4

This pool vacuum hose fits all the standard vacuum heads
Size: 11m x 38mm, Robust construction. Durable plastic spiral construction. Comes with 2 end cuffs.



**POOL HOSE
38 MM X 12 M**

HOS3812 BLAC

Ctn Qty: 5

Heavy duty, crush resistant pool hose. UV and chemical resistant ensuring the hose is durable and built to last. Comes with swivel cuffs providing flexibility and kink-free operation. 12m x 38mm.

POOL & SPA EQUIPMENT
CONSUMABLES



POOL HOSE CUFFS 38 MM

HOC38

Ctn Qty: 72

Allows your vacuum hose to swivel which helps make the job of vacuuming your pool quicker and easier.



**BOREAL SPA POOL KIT
3 PC**

PK17CS/SPA

Ctn Qty: 8

Includes 3-pc Pole, skimmer net 23cm x 20cm, brush 13cm W. Includes removable Handle EZ-grip.



**BOREAL SPA POOL KIT
7 PC**

PK20CBX/SPA

Ctn Qty: 4

The kit includes a brush, a skimmer net, a scrubbing glove, a 3-section aluminum handle, two absorbent sponges, a floating thermometer, and a chemical dispenser.



**WISHBONE FOR
TELESCOPIC POLES**

POW

Ctn Qty: N/A

Wishbone Clips are hose attachments for telescopic handles that help lock the handle in place to achieve the right height and length for your needs. Fits most standard poles.



LEAF SCOOP

LEAS

Ctn Qty: 6

Lightweight streamlined design effortlessly skims leaves and debris floating on water's surface.



**WIDE MOUTH SKIMMER
BASKET**

SKB

Ctn Qty: N/A

Skimmer basket replacement, fits Vogue Pools.

POOL & SPA EQUIPMENT
CONSUMABLES



**JETZO CARTRIDGE
CLEANER NOZZLE**

K140CS/SPA

Ctn Qty: 24

Cleans filter cartridges to improve filtration and extend their life. Button to start and stop water flow. Connects to standard garden hose.



**JET VAC KIT WITH 5 X
SECTION POLE 120 CM**

K189CS/B

Ctn Qty: 6

Simply attach your garden hose to the vacuum head which will create a vacuum effect and pick up the debris on the pool floor whilst moving it backwards and forwards. The Jet Vac includes a 5 section pole and debris bag.



KOKIDO 6 PC POOL KIT

K485CS/3W

Ctn Qty: 6

includes a brush, a rake, a jet vac, a floating dispenser, a pack of multi-pills to remove debris and a thermometer to check the temperature. This kit makes a great essential for your new pool.



SOLARIS AG COVER REEL

K651CBX

Ctn Qty: 2

Complete set includes reel, mounting hardware, 7-piece hexagonal tube set, and strap kit. Suitable for above ground pools up to 18' wide.



**KOKIDO STEP N WASH
POOL FOOT BATH**

K672BU

Ctn Qty: 12

Helps prevent grass and dirt from being carried into the pool and therefore may reduce chemical consumption and frequency of cleaning.



LEAF RAKE

LEAR

Ctn Qty: 12

Scoops out small debris and floating garbage from your swimming pool, pond, hot tub, fountain or large fish tank. Its fine mesh bag is deep and retains the debris while letting the water go.

POOL & SPA EQUIPMENT
CONSUMABLES



**ROUND TUBULAR
THERMOMETER**

THF

Ctn Qty: 12

Measures in Celsius and Fahrenheit, includes cord 190mm long.



**LUV-A-DUCK SERIES
THERMOMETER**

TM08CB

Ctn Qty: 12

Original and playful pattern, measures pool temperature. Securing cord with hook to hold on stairs & suction cup to hold on pool wall.



POOL AND SPA CHEMICALS

BALANCE CHEMICALS



Water balance is a crucial aspect in pool maintenance. Maintaining a healthy pH balance ensures that your sanitising chemicals are working efficiently, decreases the probability of problems such as algae growth and prolongs your pool and pool equipment.





pH BUFFER

SKU: CPHB

pH Buffer (Sodium Bicarbonate) has the ability to resist changes in the pH levels of water and buffers the water from wild pH swings. It will raise the total alkalinity in swimming pools and spa pools.

| SIZES | CODE | CARTON QTY |
|-------|--------|------------|
| 1kg | CPHB01 | 12 |
| 2kg | CPHB02 | 6 |
| 4kg | CPHB04 | 4 |
| 10kg | CPHB10 | 2 |
| 25kg | PHB25 | N/A |



pH INCREASE

SKU: CPHI

pH Increase (Soda Ash) is used to raise pH levels in swimming pools and spa pools.

| SIZES | CODE | CARTON QTY |
|-------|----------|------------|
| 1kg | CPHI01 | 12 |
| 2kg | CPHI02 | 6 |
| 4.5kg | CPHI04.5 | 4 |
| 25kg | PHI25 | N/A |



pH DECREASE

SKU: CPHD

pH Buffer (Sodium Bicarbonate) resists changes in the pH levels of water and buffers the water from wild pH swings. It will raise the total alkalinity in swimming pools and spa pools.

| SIZES | CODE | CARTON QTY |
|-------|----------|------------|
| 1kg | CPHD01 | 12 |
| 2kg | CPHD02 | 6 |
| 4.5kg | CPHD04.5 | 4 |
| 10kg | CPHD10 | N/A |
| 25kg | PHD25 | N/A |

*ALSO AVAILABLE IN:

- 1KG TABLETS (CPHDT01) - CARTON QTY (12)
- 1KG SALT POOL PH DECREASE TABLETS (SAPHDT01) - CARTON QTY (6)



HYDROCHLORIC ACID SKU: CHYA

Hydrochloric Acid (25% concentration) can be used to reduce the pH and/or total alkalinity of a pool.

| SIZES | CODE | CARTON QTY |
|-------|----------|------------|
| 5L | CHYA0525 | 4 |
| 20L | CHYA2025 | N/A |



CHLOR SAVE SKU: CCHS

Chlor Save (Cyanuric Acid) is a stabiliser used to slow down the rate at which free chlorine is destroyed by sunlight.

| SIZES | CODE | CARTON QTY |
|-------|----------|------------|
| 1.5kg | CCHS01.5 | 6 |
| 3kg | CCHS03 | 4 |
| 10kg | CCHS10 | N/A |
| 25kg | CHS25 | N/A |

*ALSO AVAILABLE IN:

- 1KG TABLETS (CCHST01) - CARTON QTY (12)
- 40KG TABLETS (CCHST40) - CARTON QTY (N/A)
- 1KG SALT POOL CHLOR SAVE TABLETS () - CARTON QTY (12)



CALCIUM HARDENER SKU: CCAH

Calcium Hardener (Calcium Chloride) is used to balance the total water hardness of your pool water, ensuring that calcium and magnesium levels are optimal.

| SIZES | CODE | CARTON QTY |
|-------|----------|------------|
| 750g | CCAHO.75 | 12 |
| 1.5kg | CCAHO1.5 | 6 |
| 3kg | CCAHO3 | 4 |
| 10kg | CCAHI0 | 2 |
| 25kg | CAH25 | N/A |

ALGAEICIDE CHEMICALS



Having an effective algaecide is one of the most important tools in the pool maintenance arsenal. They are designed to kill algae, which can grow in your pool if you don't take care of it. There are many dangers of not treating algaecide, including skin issues and bacterial infections.





CLEAN THE GREEN

SKU: CLG01

Clean The Green helps in the removal and prevention of green black mustard blue-green and other swimming pool algae. Can also be used on hard surfaces such as paths paving asphalt driveways and timber.

SIZES

1L

CODE

CLG01

CARTON QTY

12



POOL KLEER

SKU: CPKA

Pool Klear is a copper and quaternary complex algaecide and sanitiser for swimming pools. Helps to keep pool water clear and free of visible algae.

SIZES

5L
20L

CODE

CPKA05
CPKA20

CARTON QTY

4
N/A



POOL WINTERISER

SKU: CWIN02

Pool Winteriser is a long-lasting winter solution for swimming pools that provides an effective barrier against algae growth through pool hibernation that lasts up to 5 months.

SIZES

2L

CODE

CWIN02

CARTON QTY

N/A



SALTE ALGAECIDE

SKU: CSAA

Salte Algaecide is a non-copper formulation making it ideal for pools with salt cell chlorine generators. An independently strong formulation with a control period up to 2 months.

| SIZES | CODE | CARTON QTY |
|-------|----------|------------|
| 1L | CSAA01 | 6 |
| 2.5L | CSAA02.5 | 6 |
| 20L | CSAA20 | N/A |



SUPER ALGAECIDE

SKU: SUA

Super Algaecide is a non-copper algaecide used for pools containing heavy black algae growth.

| SIZES | CODE | CARTON QTY |
|-------|-------|------------|
| 1L | SUA01 | 6 |
| 5L | SUA05 | 4 |



COMMERCIAL ALGAECIDE

SKU: Q5020CA

Strong algaecide used in high-maintenance pools with higher bather load. Suitable for chlorine or salt pools. Does not contain copper.

| SIZES | CODE | CARTON QTY |
|-------|---------|------------|
| 20L | Q5020CA | N/A |

SANITISER CHEMICALS



Pool and spa sanitisers are used to kill and eliminate any harmful bacteria in your water, keeping sanitation levels safe and your pool or spa ready to use whenever you please.





LIQUA CHLOR

SKU: CLCH

Liquid Chlorine (Sodium Hypochlorite >15%) is effective against most bacteria algae and other micro-organisms and is excellent for maintaining a free chlorine residual in pool water.

| SIZES | CODE | CARTON QTY |
|-------|---------|------------|
| 5L | CLCH05 | 4 |
| 10L | CLCH10 | N/A |
| 20L | CLCH20 | N/A |
| 100L | CLCH100 | N/A |



CHLORINE GRANULES

SKU: CPCG

Chlorine Granules (Calcium Hypochlorite 70% Concentration) is an ideal water sanitiser for both shock and maintenance dose summer and winter use.

| SIZES | CODE | CARTON QTY |
|-------|--------|------------|
| 2kg | CPCG02 | 6 |
| 4kg | CPCG04 | 4 |
| 10kg | CPCG10 | N/A |
| 25kg | CPCG25 | N/A |
| 40kg | CWCG40 | N/A |



DICHLOR GRANULES

SKU: CDIC

Dichlor Granules is 100% soluble, fast-dissolving stabilised chlorine granules for the control of algae and bacteria in swimming pools.

| SIZES | CODE | CARTON QTY |
|-------|--------|------------|
| 2kg | CDIC02 | 6 |
| 5kg | CDIC05 | 4 |
| 10kg | CDIC10 | N/A |
| 25kg | CDIC25 | N/A |



TRICHLOR TABLETS

SKU: CTRI

Trichlor Tablets are slow-dissolving tablets that provide a source of chlorine to sanitise your pool water. They are stabilised to protect chlorine from UV degradation.

| SIZES | CODE | CARTON QTY |
|-------|--------|------------|
| 1kg | CTRI01 | 6 |
| 2kg | CTRI02 | 6 |
| 4kg | CTRI04 | 4 |
| 10kg | CTRI10 | 1 |
| 20kg | CTRI20 | N/A |
| 40kg | CTRI40 | N/A |



TRICHLOR PILLS

SKU: CTRP

Trichlor Pills (20G) automatically chlorinate the water without the need for daily dosing. They are less susceptible to degradation by sunlight. Ideal for small splasher & Intex type pools.

| SIZES | CODE | CARTON QTY |
|-------|--------|------------|
| 1kg | CTRP01 | 12 |
| 2kg | CTRP02 | 6 |
| 20kg | CTRP20 | 1 |



MULTI TABLETS

SKU: CMUT

Crystal Water Multi Tablets (200G) is a slow-dissolving, 4-way-action sanitiser: Chlorine (sanitiser), Cyanuric (stabiliser), Floc (drops suspended particles), Algaecide (inhibits algae growth).

| SIZES | CODE | CARTON QTY |
|-------|--------|------------|
| 1kg | CMUT01 | 6 |
| 2kg | CMUT02 | 6 |
| 4kg | CMUT04 | 4 |
| 40kg | MUT40 | N/A |



MULTI PILLS

SKU: CMUP01

Crystal Water Multi Pills are a slow-dissolving, 4-way-action sanitiser: Chlorine (sanitiser), Cyanuric (stabiliser), Flocc (drops suspended particles), Algaecide (inhibits algae growth). 1 container contains 50 pills.

| SIZES | CODE | CARTON QTY |
|-------|--------|------------|
| 1kg | CMUP01 | 6 |



INSTA CHLOR

SKU: CIN0.6

Insta Chlor is a 100% soluble, fast-dissolving stabilised chlorine for the control of algae and bacteria in swimming pools. Comes in a resealable bag.

| SIZES | CODE | CARTON QTY |
|-------|--------|------------|
| 600g | CIN0.6 | 10 |



REFRESH

SKU: CREFC0.6

Crystal Water Refresh is a quick pick-me-up fast action chlorine solution to boost water clarity and cleanliness. Simply pour and swim as the pool will be good to go after 60 minutes.

| SIZES | CODE | CARTON QTY |
|-------|----------|------------|
| 600g | CREFC0.6 | 20 |



BROMINE TABLETS

SKU: CBRT

Bromine Tablets (20G) are effective as a spa and hot tub water sanitiser. They have been designed to keep spa and hot tub water sparkling clean by continuous treatment through a feeder (brominator) or the skimmer.

| SIZES | CODE | CARTON QTY |
|-------|--------|------------|
| 1kg | CBRT01 | 12 |
| 2kg | CBRT02 | 6 |
| 20kg | CBRT20 | N/A |



SPA CHLOR

SKU: CSPC

Spa Chlor is an effective and convenient sanitiser to prevent growth of bacteria and algae in your spa pool.

| SIZES | CODE | CARTON QTY |
|-------|--------|------------|
| 1kg | CSPC01 | 6 |
| 2kg | CSPC02 | 6 |



LIQUID LITHIUM

SKU: LLS01

Spa pool sanitiser alternative. Liquid Lithium has minimal odour (no nasal irritation). Approx. 20 mls per day/per use for 1000L spa.

| SIZES | CODE | CARTON QTY |
|-------|-------|------------|
| 1kg | LLS01 | 6 |

POOL & SPA CHEMICALS
SANITISER CHEMICALS



SPA SHOC SHOT

SKU: CPSP01

Spa Shoc Shot automatically chlorinates the water without the need for daily dosing. Ideal for small tablet dispensers for spa pools.

SIZES

1kg

CODE

CPSP01

CARTON QTY

6



SPA BRILLIANCE

SKU: CSPSG01

Used as a regular or shock treatment in spas and hot tubs. Contains buffering agents that assists in stabilising water pH levels, Sodium Tetraborate for water softness and floc to clarify water.

SIZES

1L
5L

CODE

LIF01
LIF05

CARTON QTY

12
4



SPECIALTY PRODUCTS



Specialty products are the icing on the cake when it comes to pool & spa care. This range includes shocks, water enhancers, clarifiers and additives that enhance the quality of your pool and spa water and create a better swimming experience.





O2 SHOCK

SKU: CO2S

O2 Shock is a non-chlorine shock treatment especially formulated for spas and pools. It will remove odours and oxidise organic contaminants with an effervescent water clearing (works in partnership with Crystal Water H2OK).

SIZES

1kg
6kg
25kg

CODE

CO2S01
CO2S06
CO2S25

CARTON QTY

12
4
1



H2OK

SKU: CH2O

H2OK is a non-chlorine treatment for spas and pools that is best when working in conjunction with Crystal Water O2 Shock.

SIZES

1L
5L

CODE

CH2O01
CH2O05

CARTON QTY

12
4



PURE ENZYMES FOR SPAS

SKU: WCSPENZ12

Water's Choice Pure Enzymes for Spas is a natural enzyme sanitiser that can be used as a natural additive to reduce the use of chemical-based sanitisers.

SIZES

354ml

CODE

WCSPENZ12

CARTON QTY

12

POOL & SPA CHEMICALS
SPECIALTY PRODUCTS



ANTI CHLOR

SKU: ANC

Anti Chlor (Sodium Thiosulphate) is a chlorine neutraliser that lowers chlorine and bromine levels in pools and spas.

| SIZES | CODE | CARTON QTY |
|-------|---------|------------|
| 1kg | ANC01 | 6 |
| 2.5kg | ANC02.5 | 4 |
| 5kg | ANC05 | 4 |
| 25kg | ANC25 | 1 |



STARVER

SKU: CSTARVER

Starver removes phosphate from water.

| SIZES | CODE | CARTON QTY |
|-------|------------|------------|
| 1L | CSTARVER01 | 12 |
| 25L | CSTARVER25 | N/A |



SINGLE SHOT POOL CLARIFIER

SKU: CWSKT125

Single Shot Clarifier removes fine particles that cannot be caught by filtration alone and clarifies dull water. Just pop them in your skimmer basket and away you go!

| SIZES | CODE | CARTON QTY |
|-------|----------|------------|
| 125g | CWSKT125 | 20 |



LIQUA FLOC

SKU: LIF

Liqua Flocc is a concentrated flocculent that clears the cloudiest pools by dropping coagulated debris to pool floor for easy vacuuming.

SIZES

1L
5L

CODE

LIF01
LIF05

CARTON QTY

12
4



ALUM FLOC

SKU: CFLA

Alum Flocc (Aluminium Sulphate) is used to clear cloudy or discoloured water containing iron or dirt particles in suspension.

SIZES

2kg
5kg
25kg

CODE

CFLA02
CFLA05
FLA25

CARTON QTY

6
4
1



CRYSTAL CLEAR

SKU: CCRC

Crystal Clear is a non-toxic, non-irritating solution that removes finely suspended particles that the filter cannot normally clean which causes cloudy and murky water.

SIZES

1L
5L

CODE

CCRC01
CCRC05

CARTON QTY

12
4



NO FOAM

SKU: NOF01

Used to combat any foaming problems in spa pools

SIZES

1L

CODE

NOF01

CARTON QTY

12



FILTER CLEANER

SKU: PSF

Pool And Spa Filter Cleaner is a concentrated cleaner to remove dirt, oil, body fat, grease and film from all types of filters.

SIZES

1L
5L

CODE

PSF01
PSF05

CARTON QTY

12
4



SALTE CELL CLEANER

SKU: SCC01

Cleans scale build up in salt water pool cells. Can also be used to clean concrete and tile pool surface.

SIZES

1L

CODE

SCC01

CARTON QTY

12



STAIN & SCALE CONTROL

SKU: SSC

Stain And Scale Control reduces the formulation of stain and scale in pools.

SIZES

1L
5L

CODE

SSC01
SSC05

CARTON QTY

12
4



VELVET TOUCH

SKU: CVET0.75

Velvet Touch is a water enhancer for spas that gives water a soft velvet feeling. It clarifies water and gives corrosion protection.

SIZES

750g

CODE

CVET0.75

CARTON QTY

12



PIPE CLEANER

SKU: PPC0.5

Removes oils, grease and other contaminants from pipe systems and cartridges in spas.

SIZES

500ml

CODE

PPC0.5

CARTON QTY

12



WE SELL MINERAL SALTS TO ENHANCE YOUR SWIMMING EXPERIENCE!

Space Industries Crystal Water is now offering mineral salts in 5kg tubs. Feel free to contact your account manager or call us on **(09) 262 3902** . Alternatively, you can email us on **reception@spaceindustries.co.nz** .



WATER'S CHOICE AROMATHERAPY SPA SALTS

Therapeutic mineral salts to add in your spa pool to enhance your spa experience! Comes in a range of 6 different fragrances (570g tub).

| SCENTS | CODE | CARTON QTY |
|---------------|----------------|------------|
| Exotic Nights | SPENZWCASEXN2 | 6 |
| Happy | SPENZWCASHPY2 | 6 |
| Refresh | SPENZWCASREF2 | 6 |
| Summer Breeze | SPENZWCASSBR2 | 6 |
| Tranquility | SPENZWCASTRN2 | 6 |
| Wellness | SPENZWCASWELL2 | 6 |



WATER'S CHOICE SPA SALTS SAMPLE PACK

SPENZWCSPASALTS

Ctn Qty: 12

Can't decide on one scent? Try all 5 scents in one pack!

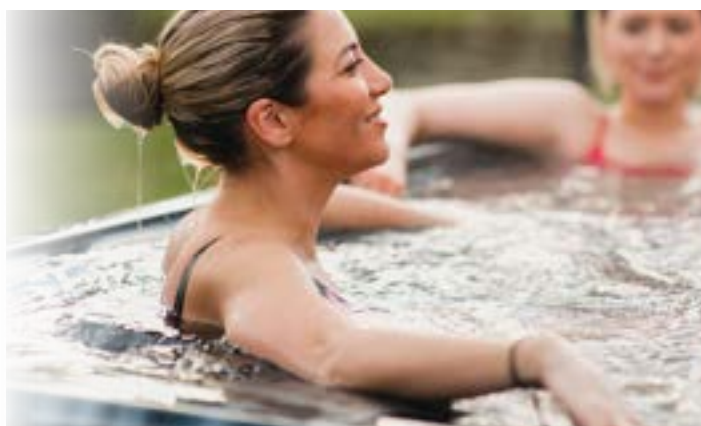

WATER TESTING



WATER TESTING

**MADE EASY WITH
OUR CRYSTAL WATER ONLINE
TOOL & AQUACHEK ©
TEST STRIPS.**

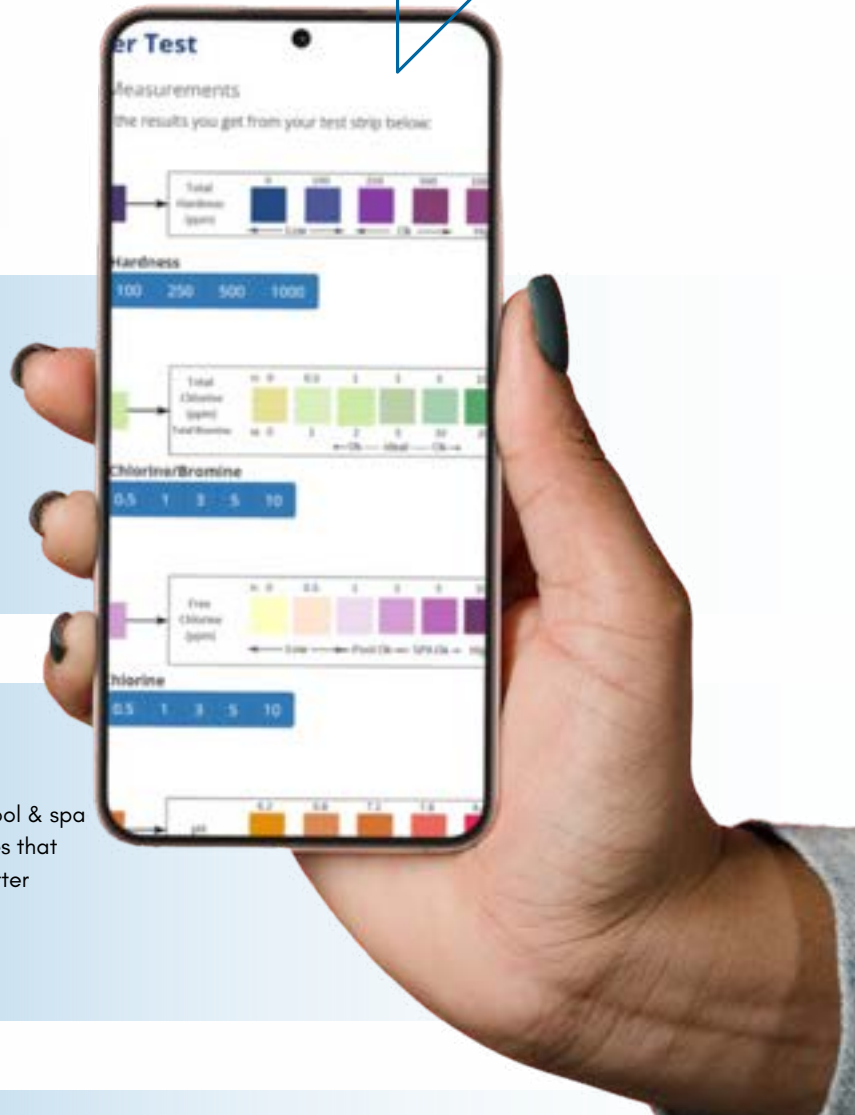

STEP 1:

Specialty products are the icing on the cake when it comes to pool & spa care. This range includes water enhancers, clarifiers and additives that enhance the quality of your pool and spa water and create a better swimming experience.

STEP 2:

Specialty products are the icing on the cake when it comes to pool & spa care. This range includes water enhancers, clarifiers and additives that enhance the quality of your pool and spa water and create a better swimming experience.

STEP 3:

Specialty products are the icing on the cake when it comes to pool & spa care. This range includes water enhancers, clarifiers and additives that enhance the quality of your pool and spa water and create a better swimming experience.

POOL & SPA EQUIPMENT
WATER TESTING



AQUACHEK GOLD SKU: AQG

Tests for Total Chlorine, Bromine, Free Chlorine, pH, Total Alkalinity, Total Hardness, Cyanuric Acid and pH.
50 TEST STRIPS.

CTN QTY: 6



AQUACHEK GOLD REFILL KIT SKU: AQGR

Refill kit for the AquaChek Gold test strips. **50 TEST STRIPS.**

CTN QTY: 6



AQUACHEK SILVER SKU: AOS

Tests for Total Chlorine, Free Chlorine, Total Bromine, Total Alkalinity, Total Hardness, Cyanuric Acid and pH.
100 TEST STRIPS.

CTN QTY: 6



AQUACHEK YELLOW SKU: AQY

Tests for Total Chlorine, Total Alkalinity and pH.
50 TEST STRIPS.

CTN QTY: 160



AQUACHEK SPA SKU: AQSPA

Tests for Total Chlorine, Free Chlorine, Total Bromine, Total Alkalinity, Total Hardness and pH. **50 TEST STRIPS.**

CTN QTY: 12



AQUACHEK SALT SKU: AQW

Tests for Sodium Chloride levels.
10 TEST STRIPS.

CTN QTY: 10

POOL & SPA EQUIPMENT
WATER TESTING



AQUACHEK MPS **SKU: AQM**

Tests for Monopersulfate, pH and Total Alkalinity.

50 TEST STRIPS.

CTN QTY: 12



AQUACHEK PHOSPHATE **SKU: AQP**

1 minute phosphate test. Contains testing powder, pillows and vial in a bottle.

20 TEST STRIPS.

CTN QTY: 6



AQUACHEK BIGUANIDE **SKU: AOS**

Tests for pH, Alkalinity and Biguanide/Bacquacil.

25 TEST STRIPS.

CTN QTY: 12



AQUACHEK PEROXIDE **SKU: AQPEROX**

Tests for Peroxide, Total Alkalinity and pH.

25 TEST STRIPS.

CTN QTY: 12



TEST TABLETS **SKU: VARIOUS**

TTN1 - DPD No 1 Free Chlorine
TTN3 - DPD No 2 Combine Chlorine
TTCA - Cyanuric Acid
TTR - Phenol Red
10 TABLETS PER STRIP.

CTN QTY: 25



TESTING SOLUTIONS **SKU: VARIOUS**

TKS2-30 - Solution 2 - 30ml
TKS4-15 - Solution 4 - 15ml
TTCA - Cyanuric Acid
TTN1 - Chlorine Free
TTN3 - Chlorine Combined
TTR - Phenol

CTN QTY: N/A



160 Plunket Ave, Wiri, Auckland
(09) 262 3902
www.spaceindustries.co.nz
reception@spaceindustries.co.nz